

ARMORTEC[®] Product Details

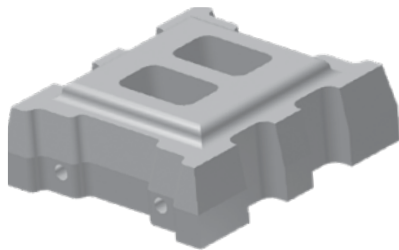

ArmorFlex[®] - Open Cell

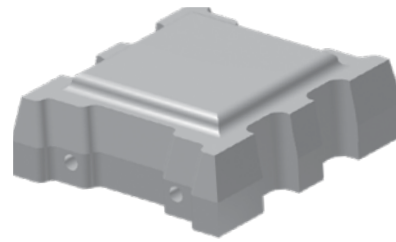

ArmorFlex[®] - Closed Cell

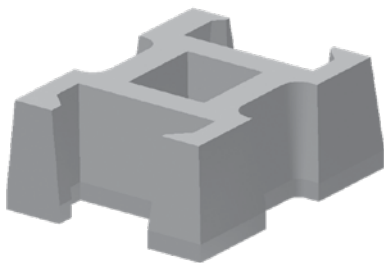

ArmorLoc[®]



A-Jacks[®]

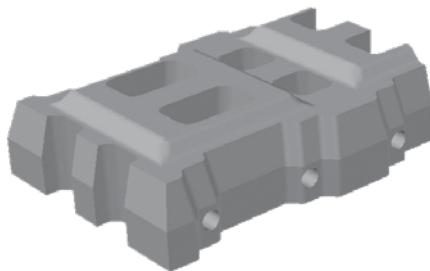

ArmorFlex[®] Block and a Half[®]

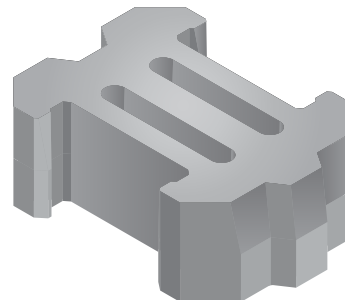

Geolink[®]

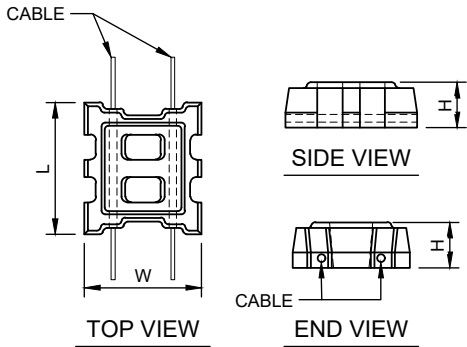

OPEN CELL BLOCK

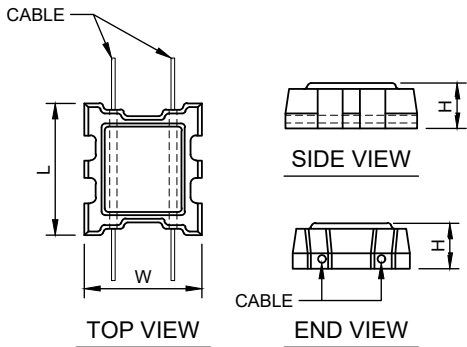

CLOSED CELL BLOCK

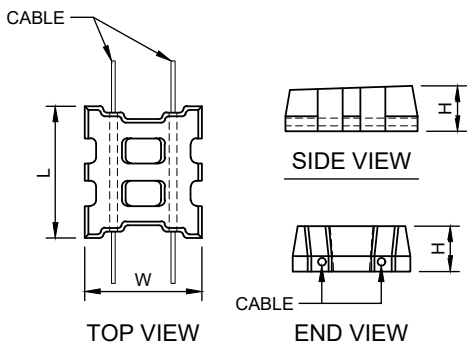

TAPERED OPEN CELL BLOCK

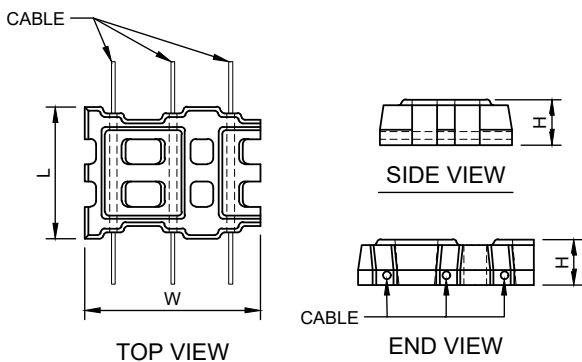

BLOCK AND A HALF BLOCK

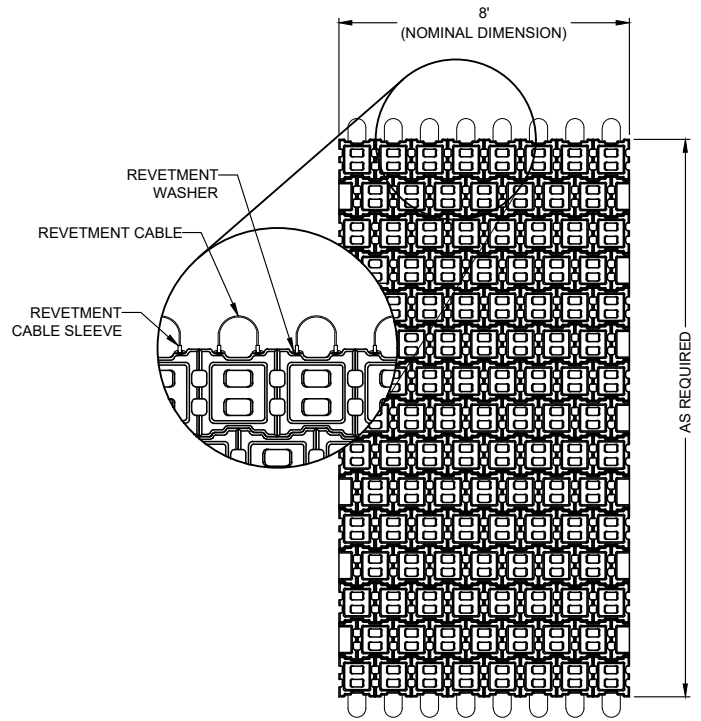

TYPICAL MAT PLAN

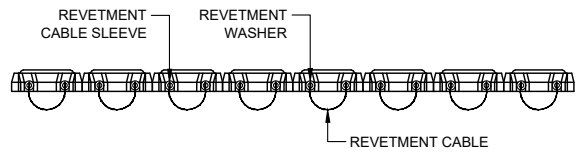

TYPICAL MAT END VIEW

ArmorFlex Unit Specification

Concrete Block Class	Nom. Dimensions (in.)			Gross Area/ (sq. ft.)	Typ. Block Weight	
	L	W	H		lbs	lbs/sq. ft.
Open Cell - 20% Open Area						
40	17.4	15.5	4.75	1.77	59	40
50	17.4	15.5	6	1.77	76	50
70	17.4	15.5	8.5	1.77	108	70
40L	17.4	23.6	4.75	2.58	97	40
50L	17.4	23.6	6	2.58	116	50
70L	17.4	23.6	8.5	2.58	174	70
Closed Cell - 10% Open Area						
45	17.4	15.5	4.75	1.77	71	45
55	17.4	15.5	6	1.77	91	55
85	17.4	15.5	8.5	1.77	136	85
45L	17.4	23.6	4.75	2.58	109	45
55L	17.4	23.6	6	2.58	138	55
85L	17.4	23.6	8.5	2.58	207	85
High Velocity Application - Tapered Open Cell - 20% Open Area						
40-T	17.4	15.5	4.75	1.77	58	40
50-T	17.4	15.5	6.00	1.77	75	50
70-T	17.4	15.5	8.50	1.77	109	70

ArmorFlex® cont. (not to scale)

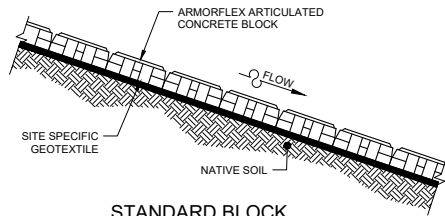

**STANDARD BLOCK
TYPICAL CROSS SECTION**

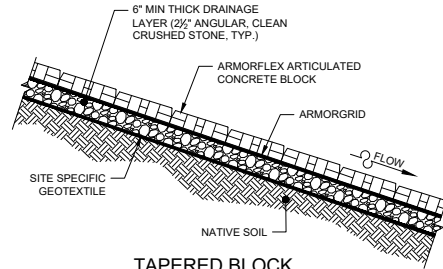

**TAPERED BLOCK
TYPICAL CROSS SECTION**

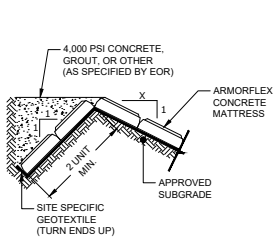

**TOP OF SLOPE
TERMINATION DETAIL**

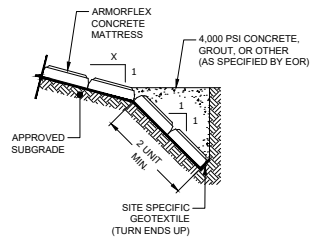

**TOE OF SLOPE
TERMINATION DETAIL**

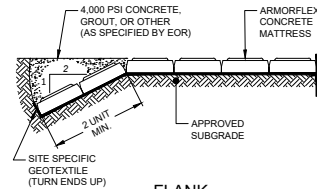

**FLANK
TERMINATION DETAIL**

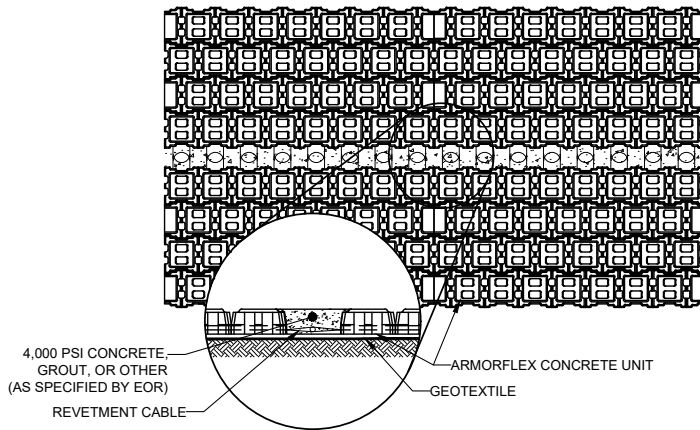

TYPICAL MAT TO MAT

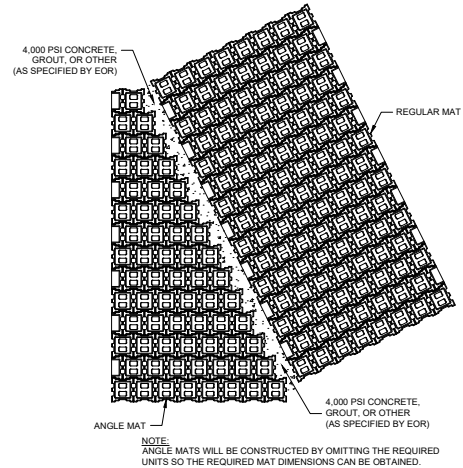

TYPICAL ANGLE MAT

A-Jacks® (not to scale)

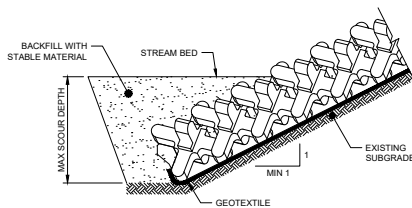
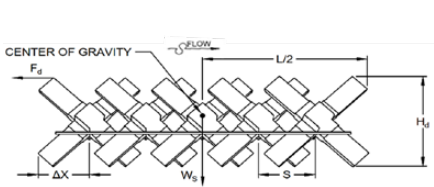

TOE TERMINATION

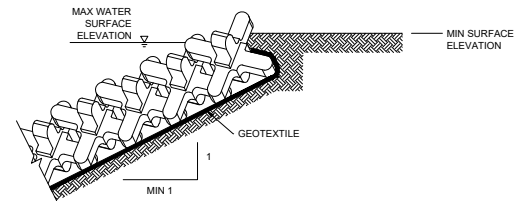

TOP TERMINATION

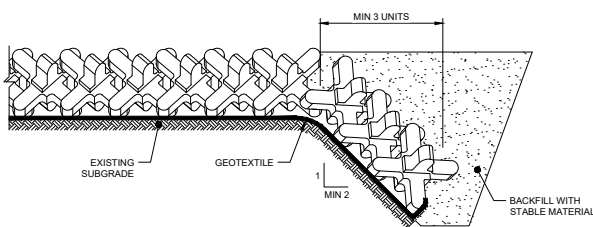

FLANK TERMINATION

A-Jacks Unit Specification

A-JACKS System	Min. Unit Weight (lbs)	Drag Coef. C_d	Spacing, S (ft)	Height, H_d (ft)	Δx (ft)
AJ-24	73.6	1.05	0.75	1.3	0.66
AJ-48	590.7	1.05	1.5	2.67	1.35

ArmorLoc® (not to scale)

ArmorLoc Unit Specification

CONCRETE BLOCK CLASS	OPEN AREA %	DIMENSIONS			GROSS AREA (SF)	MIN. BLOCK WEIGHT (LBS)
		L	W	H		
3510	25	15.875	11.875	4	1.0	30
4511	20	15.875	11.875	5.25	1.1	45
5011	20	15.875	11.875	6	1.1	50

*Open-cell block shown. Closed-cell block also available.

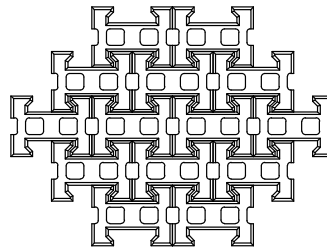
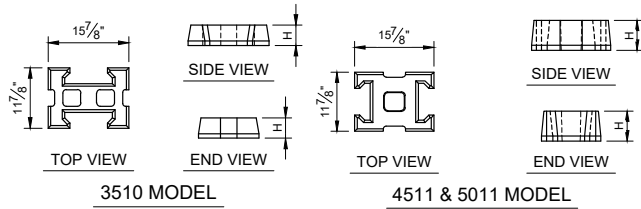

3510 PLAN VIEW

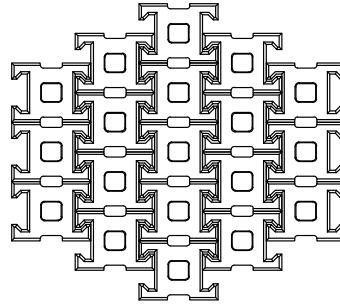

4511 & 5011 PLAN VIEW

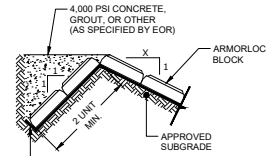

TOP OF SLOPE TERMINATION DETAIL

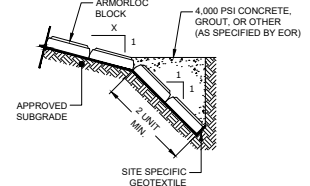

TOE OF SLOPE TERMINATION DETAIL

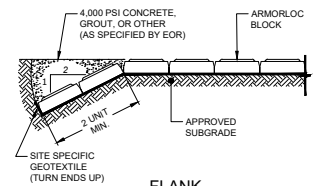

FLANK TERMINATION DETAIL

Geolink® (not to scale)

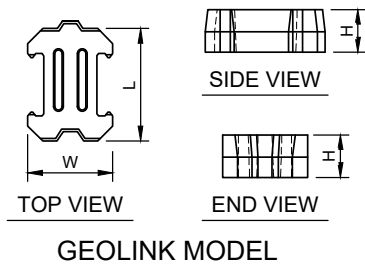

GEOLINK MODEL

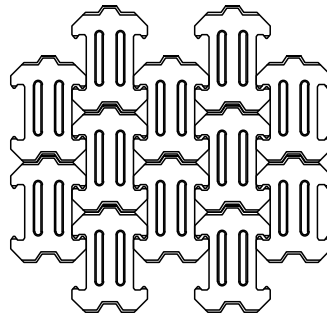

GEOLINK PLAN VIEW

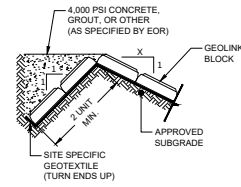

TOP OF SLOPE TERMINATION DETAIL

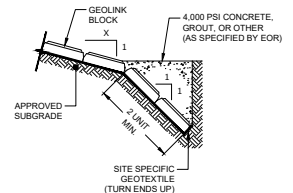

TOE OF SLOPE TERMINATION DETAIL

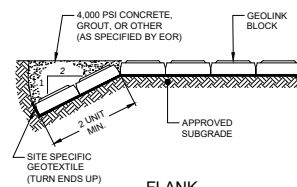

FLANK TERMINATION DETAIL

ArmorLoc Unit Specification

CONCRETE BLOCK CLASS	OPEN AREA %	DIMENSIONS			GROSS AREA (SF)	MIN. BLOCK WEIGHT (LBS)
		L	W	H		
GL4	20	16	12	4	1.12	36
GL6	20	16	12	6	1.12	55

ARMORTEC Minimum Physical Requirements per ASTM D6684

MIN. DENSITY (IN AIR) LBS/FT ³		MIN. COMPRESSIVE STRENGTH PSI		MAX WATER ABSORPTION LBS/FT ³	
Avg. of 3 Units	Individual Unit	Avg. of 3 Units	Individual Unit	Avg. of 3 Units	Individual Unit
130	125	4,000	3,500	9.1	11.7